

Insert paper roll

- ▶ Press the unlocking surface on the printer panel, the printer drawer opens.
- ▶ Pull the printer drawer out of the DTCO.

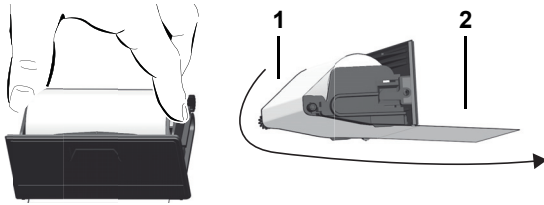

- ▶ Insert new paper roll according to the illustration and guide it via the pulley (1).
- ▶ Make sure that the paper roll does not become jammed in the printer drawer and the start of the paper (1) extends beyond the edge of the printer drawer!
- ▶ Push printer drawer into the printer compartment until it engages.
- ▶ The printer is ready for operation.
You can start a printout.

Messages

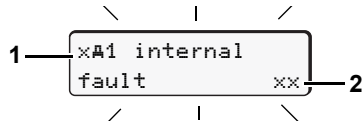

- (1) Pictogram and plain text of the message
 != Event, example [! sensor drivings without card]
 x = Fault, example [x! sensor fault]
 † = Driving time warning [†! break!]
 Operational note, example [†! no paper]

(2) Error code

For further messages and measures refer to the operating instructions.

Acknowledge message:

- ▶ Press key **OK** 2 times, the message disappears.

Times of the driver card(s)

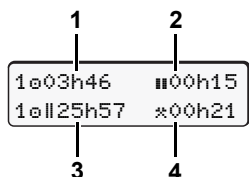

- (1) Driving time "a" since a valid break time.
 (2) Valid break time "||", in accordance with regulation (EU) no. 561/2006.
 (3) Driving time over two weeks "a||".
 (4) Duration of the set activity.

Calling up menu functions

Possible only when the vehicle is stationary!

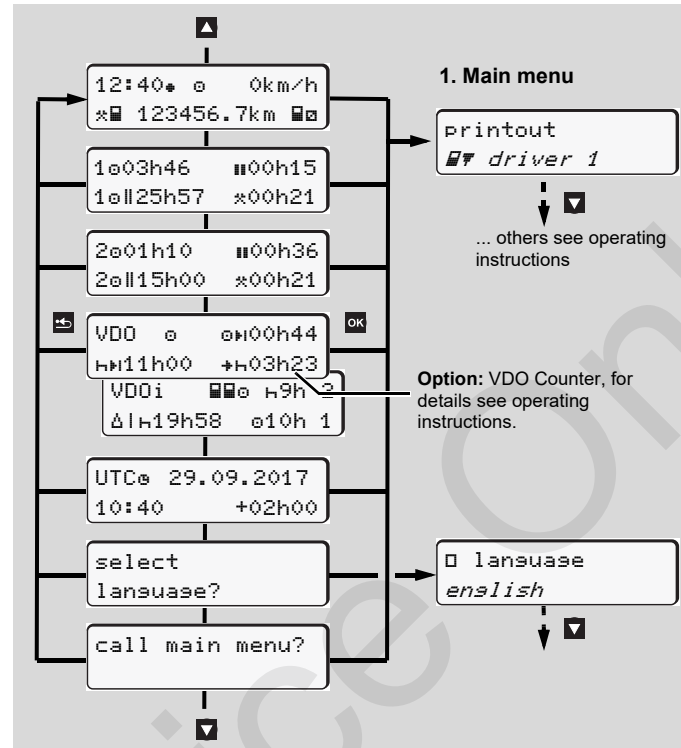

- ▶ Use the buttons **▲/▼** to select the desired display.
- ▶ Use button **OK** to call up the main menu.
- ▶ Use **▲/▼** to select the listed functions step by step.

Print daily value:

- ▶ [printout **driver 1**] ... [24h **day**] ... [25.10.2017] ... [printout in UTC yes/no]

Enter "Out of scope" beginning / end:

- ▶ [entry **vehicle**] ... [OUT+ **begin**] or [+OUT **end**]

Enter Beginning of ferry / train:

- ▶ [entry **vehicle**] ... [**ferry/train**]
- ▶ Set the current activity.

Set Local time:

- ▶ [entry **vehicle**] ... [**local time**] ...
- ▶ Set Local time in steps of ± 30 minutes.

Brief instructions Driver

DTCO® 1381 – Release 3.0

A2C13870700 / 41024284 OPM 000 AA

BA00.1381.30 500 102

(GB)

www.fleet.vdo.com



Operational elements

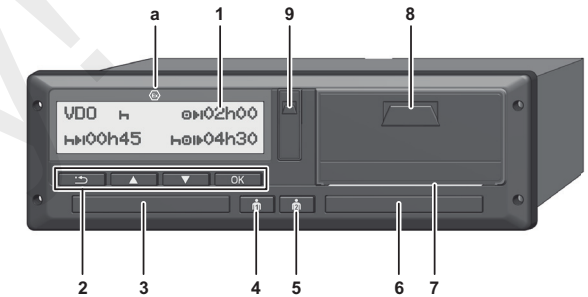

- (1) Display
 (2) Menu buttons
▲/▼ Select function / selection
OK Confirm function / selection
EXIT Exit, abort menu
 (3) Card slot 1
 (4) Combination key Driver 1
 Setting of activities and ejection of the driver card
 (5) Combination key Driver 2
 Setting of activities and ejection of the driver card
 (6) Card slot 2
 (7) Cutting edge
 (8) Printer drawer
 (9) Download interface
 (a) Symbol for ADR variant

Standard display(s) during trip

- ▶ Press any menu key, change to the desired display.

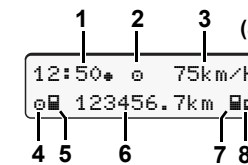

- (1) Time (with "*" = set local time)
 (2) "Operational mode"
 (3) Speed
 (4) Activity, driver 1
 (5) Card symbol, driver 1
 (6) Total odometer
 (7) Card symbol, driver 2
 (8) Activity, driver 2

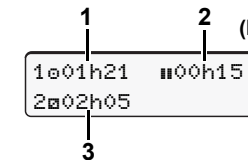

- (1) Driving time "a" Driver 1 since a valid break time.
 (2) Valid break time "||", in accordance with regulation (EU) no. 561/2006.
 (3) Time of driver 2; availability time "a".

The option "VDO Counter" allows another standard display; for details refer to the operating instructions.

These brief instructions shall not, under any circumstances, be regarded as a substitute for the exhaustive operating instructions for the DTCO 1381 prescribed by EU Regulation (EEC) no. 3821/85, Annex I B.

Insert driver card / Manual entries

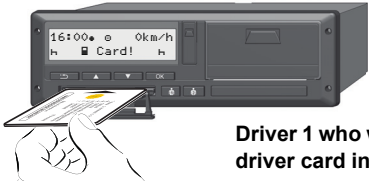

Driver 1 who will drive the vehicle inserts his driver card into slot 1.

- ▶ If necessary, switch on the ignition in case of the ADR variants.
- ▶ Keep the combination key Driver 1 for more than 2 seconds. The card slot is opened.
- ▶ Open the card slot cover.
- ▶ Insert driver card into the card slot.
- ▶ Close card slot and push it in.
- ▶ Follow the menu guidance.

Always keep the card shafts closed – except for the insertion or removal of your driver card!

welcome
07:35* 05:35UTC

The set local time "07:35*" and the UTC time "05:35UTC" appear (time offset = 2 hours).

last withdrawal
15.04.17 16:31*

The date and time of the most recent card withdrawal will be displayed in local time (symbol "*").

1M entry addition?
yes

Please ensure the continuous recording of the activities on your driver card!

Make manual entries with "Yes".

If you **do not want** to add any activities/rest periods, select "No".

continue with example:
A/B/C

Example A: Withdrawal (15.04.2017) 16:31 Local time Insertion (18.04.2017) 07:35 Local time

M 15.04.17 16:31
H 18.04.17 07:35

- ▶ Press and hold key **OK**.
 - ▶ Automatic jump to the last entry field (minutes blink).
 - ▶ Release button **OK** and press it again.
- Appears when "End country" was entered during the last withdrawal.

M 15.04.17 16:31
H 18.04.17 07:35

besin country
:UK

- ▶ Acknowledge entry.

1M confirm entry?
yes

07:36* 0km/h
H 123456.7km H

"H" = Trip can be started.

Example B:

M 24.02.17 23:32
H 25.02.17 02:30

* 25.02.17 02:30
* 25.02.17 00:20

M 25.02.17 00:20
H 25.02.17 02:30

25.02.17 02:30

besin country
:UK

1M confirm entry?
yes

02:31* 0km/h
H 123456.7km H

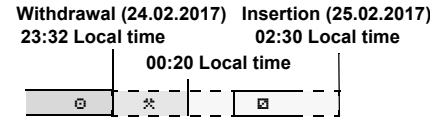

- ▶ Set, acknowledge activity "*".
- ▶ Set, acknowledge day, hours, minutes.
- ▶ Set, acknowledge the next activity "H".
- ▶ Press and hold key **OK** (the minutes blink).
- ▶ Release button **OK** and press it again.
- ▶ Acknowledge entry.

Example C:

M 05.11.17 17:50
H 14.11.17 14:00

* 05.11.17 18:45

M 05.11.17 18:45
H 14.11.17 14:00

? 14.11.17 12:10

M 14.11.17 12:10
H 14.11.17 14:00

14.11.17 14:00

besin country
:UK

1M confirm entry?
yes

14:01* 0km/h
H 123456.7km H

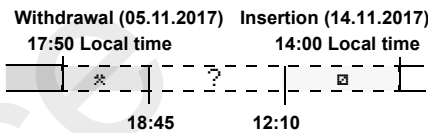

end country
:UK

bes. country
:UK

- Use key **ESC** in order to ...
- abort the entry of a country,
 - select the possible variables (backspace) directly in the entry block.

Withdrawing driver card

- ▶ If necessary, switch on the ignition in case of the ADR variants.
- ▶ Press the corresponding combination button for more than 2 seconds.
- ▶ Follow the menu guidance.

end country
:E
E AN

- ▶ Select, acknowledge the country.
- ▶ If present, select region, acknowledge.
- ▶ With button **ESC** you can abort the entry of a country if you, for example, want to continue your work shift.
- ▶ The card shaft is opened to withdraw the driver card.
- ▶ Withdraw driver card
- ▶ Close card slot and push it in.

15:05* 0km/h
H 123456.7km H

Setting activities

- o = Driving time (automatic when driving)
- * = All other working times (Automatically when the vehicle is stopped, for driver 1)
- o = Availability: Waiting times, co-driver time, sleeper-cab time during the trip (Automatically when driving or when the vehicle is stopped, for driver 2)
- H = Break times and rest periods

- ▶ **Driver 1:** Press the combination key Driver 1 repeatedly for a short time until the desired activity (H o *) is shown in the display.
- ▶ **Driver 2:** Press the combination key Driver 2 repeatedly for a short time until the desired activity (H o *) is shown in the display.

At the end of a shift or during a break, always set activity "H"!

Automatic setting after ignition on/off (option):

18:01* 0km/h
H 123456.7km H

Signalled by flashing of the activity or activities for approx. 5 seconds in the standard display (a). Then, the previous display will appear again.

- ▶ As required, change the activity accordingly!
- Symbol "*" after ignition off means: IMS function (Independent Motion Signal) available.
- Symbol "i" after ignition off means: The recording of position and vehicle data is switched on.

These brief instructions shall not, under any circumstances, be regarded as a substitute for the exhaustive operating instructions for the DTCO 1381 prescribed by EU Regulation (EEC) no. 3821/85, Annex I B.